

WILLIAMS STONE COMPANY, INC.

1158 Lee-Westfield Road P.O. Box 278 East Otis, MA 01029
 Tel: (800) 832-2052 (413) 269-4544 Fax: (413) 269-6148
 E-mail: info@williamsstone.com Web: www.williamsstone.com

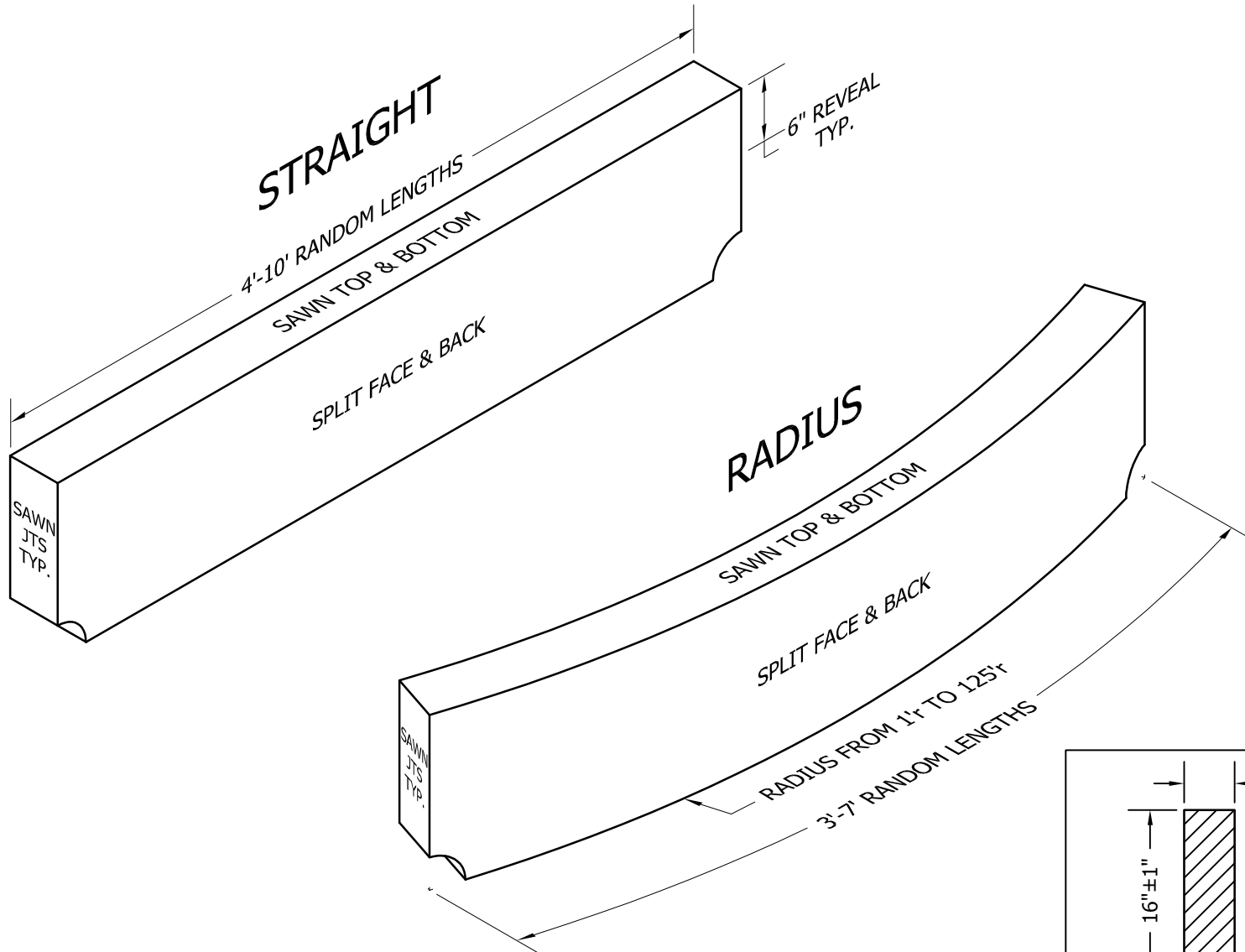

Isometric
1" = 1'-0"

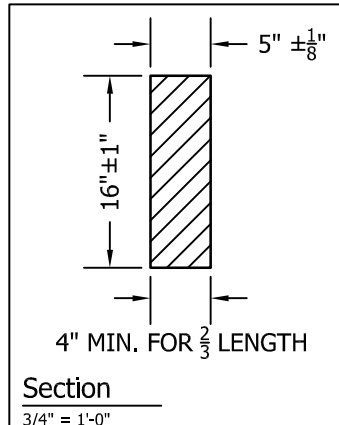

Product Code:	516S / 516R				Unit Weight:	89#/LF
Item Description:	5"x16" Vertical Curb				Stone Type:	Blue Sky
Surface:	Top	Bottom	Front	Back	Left End	Right End
Finishes:	Sawn	Sawn	Split	Split	Sawn	Sawn
Tolerances:	Items are fabricated to tolerances per the National Building Granite Quarries Association specifications.					