



# WILLIAMS STONE COMPANY, INC.

1158 Lee-Westfield Road P.O. Box 278 East Otis, MA 01029  
Tel: (800)832-2052 (413)269-4544 Fax: (413)269-6148  
E-mail: info@williamsstone.com Web: www.williamsstone.com

## (5x16) 4' Vertical to Berm Granite Transition Curb

### Straight & Radius

(as manufactured by Williams Stone Co. Inc.)

right

left

Straight

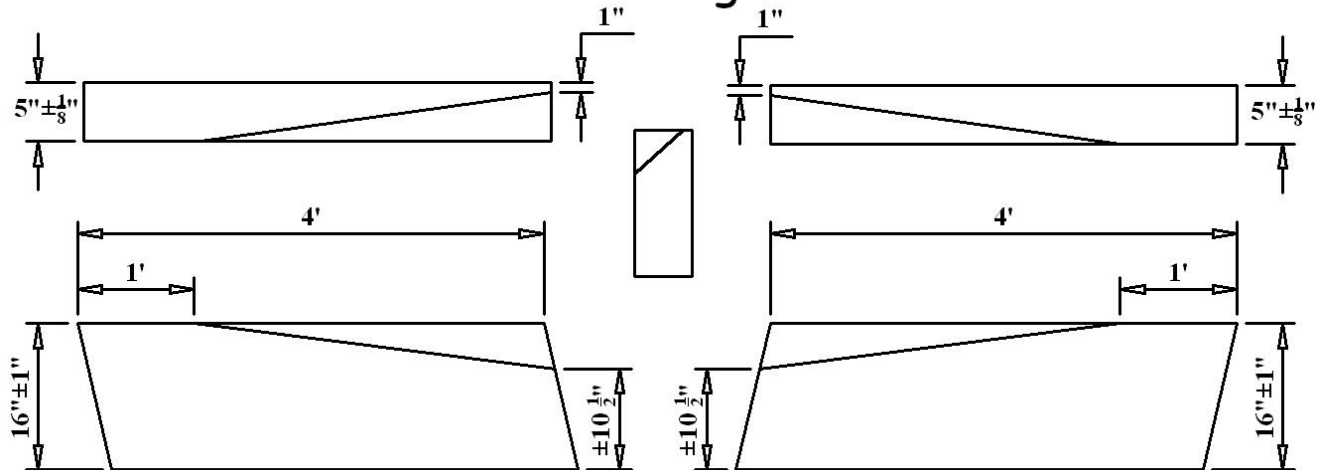

Radius

